

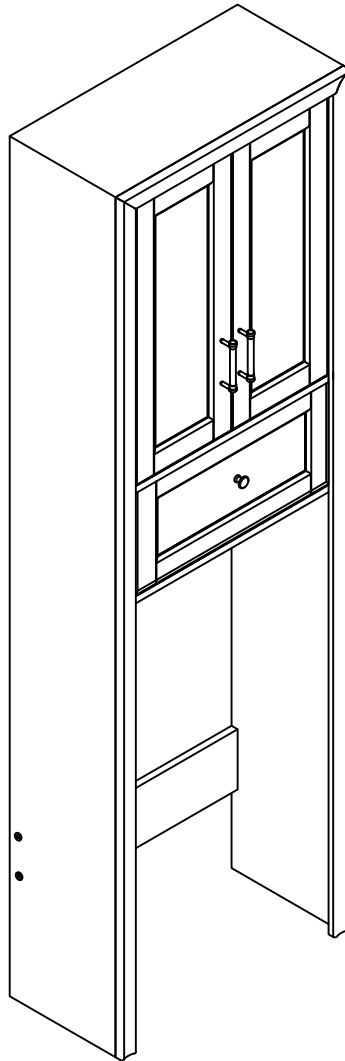

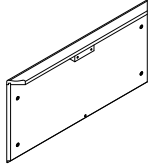

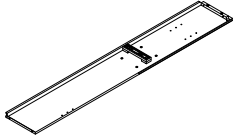

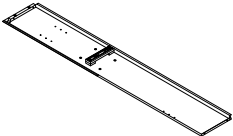

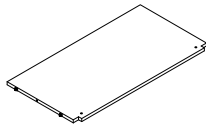
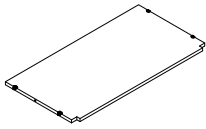
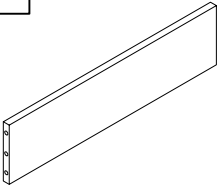
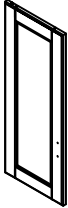
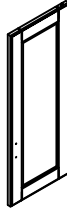
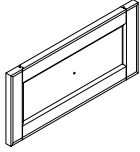
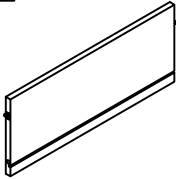
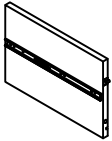
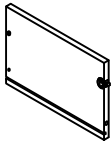
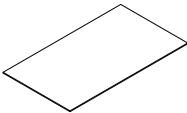
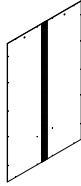
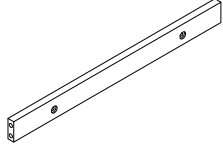
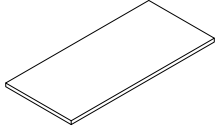

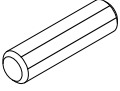
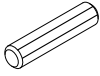
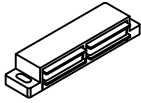
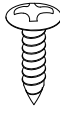

Space Saver Cabinet
CF7008

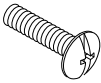
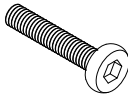
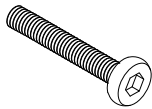

PART LIST

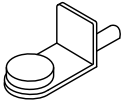
<p>A</p> 	<p>B</p> 	<p>C</p> 	<p>D</p> 	<p>E</p> 
<p>Top Panel 1 PC</p>	<p>Left Side Panel 1 PC</p>	<p>Right Side Panel 1 PC</p>	<p>Upper Fixed Shelf 1 PC</p>	<p>Lower Fixed Shelf 1 PC</p>
<p>F</p> 	<p>G</p> 	<p>H</p> 	<p>I</p> 	<p>J</p> 
<p>Bottom Rail 1 PC</p>	<p>Left Door 1 PC</p>	<p>Right Door 1 PC</p>	<p>Drawer Front Panel 1 PC</p>	<p>Drawer Back Panel 1 PC</p>
<p>K</p> 	<p>L</p> 	<p>M</p> 	<p>N</p> 	<p>O</p> 
<p>Drawer Left Side Panel 1 PC</p>	<p>Drawer Right Side Panel 1 PC</p>	<p>Drawer Bottom Panel 1 PC</p>	<p>Back Panel 1 PC</p>	<p>Top Rail 1 PC</p>
<p>P</p>  <p>Adjustable Shelf 1 PC</p>				

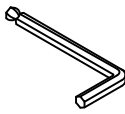
HARDWARE LIST

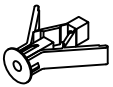
<p>#1</p>  <p>Ø8*30mm</p>	<p>#2</p>  <p>Ø6*30mm</p>	<p>#3</p> 	<p>#4</p>  <p>12*Ø3*D6mm</p>	<p>#5</p> 
<p>Large Wood Dowel 8 PCS(Extra 1)</p>	<p>Small Wood Dowel 5 PCS(Extra 1)</p>	<p>Magnet 1 PC</p>	<p>Round Head Screw 3 PCS(Extra 1)</p>	<p>Handle 2 PCS</p>
<p>#6</p> 	<p>#7</p>  <p>1/2"*Ø5/32"*D9mm</p>	<p>#8</p>  <p>3/4"*Ø5/32"*D9mm</p>	<p>#9</p>  <p>1-1/4"*Ø1/4"*D11mm</p>	<p>#10</p>  <p>2"*Ø1/4"*D11mm</p>
<p>Knob 1 PC</p>	<p>Short Round Head Bolt 2 PCS(Extra 1)</p>	<p>Long Round Head Bolt 5 PCS(Extra 1)</p>	<p>Short Bolt 5 PCS(Extra 1)</p>	<p>Long Bolt 5 PCS(Extra 1)</p>
<p>#11</p> 	<p>#12</p> 	<p>#13</p>  <p>12*Ø3*D8mm</p>	<p>#14</p> 	<p>#15</p>  <p>38mm*Ø4"*D8mm</p>
<p>Barrel Nut 4 PCS</p>	<p>Shelf Holder 5 PCS(Extra 1)</p>	<p>Screw 21 PCS(Extra 1)</p>	<p>Allen Wrench 1 PC</p>	<p>Long Round Head Screw 3 PCS(Extra 1)</p>
<p>#16</p>  <p>Wall Anchor 2 PCS</p>				

ADDITIONAL TOOLS (Not Provided)

Note: It is not recommended to use power tools during assembly.

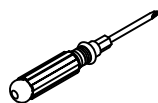

Phillips Head Screwdriver

Please do not use tools to assemble this unit unless specifically indicated.

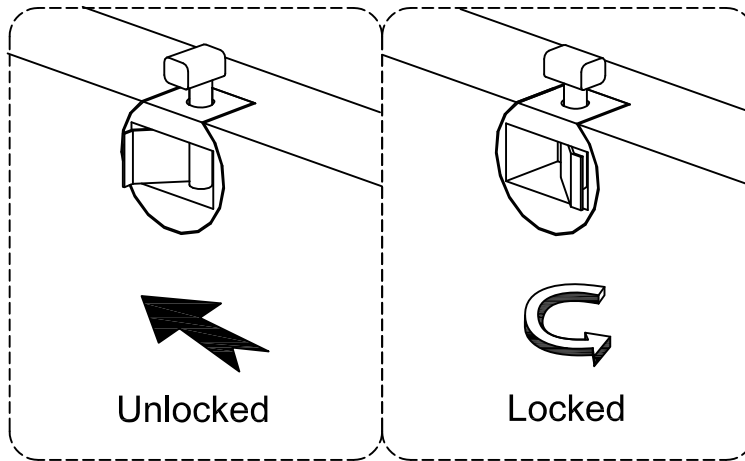

Reference the images above any time the instructions state "lock the hardware".
 Note: Be sure to check all hardware is locked when completed.

Step 1. Attach magnet (part #3) to top panel (part A) using round head screws (part #4) and phillips head screwdriver. Attach knob (part #6) to drawer front panel (part I) using short round head bolt (part #7) and phillips head screwdriver. Attach handles (part #5) to left door (part G) and right door (part H) using long round head bolts (part #8) and phillips head screwdriver.

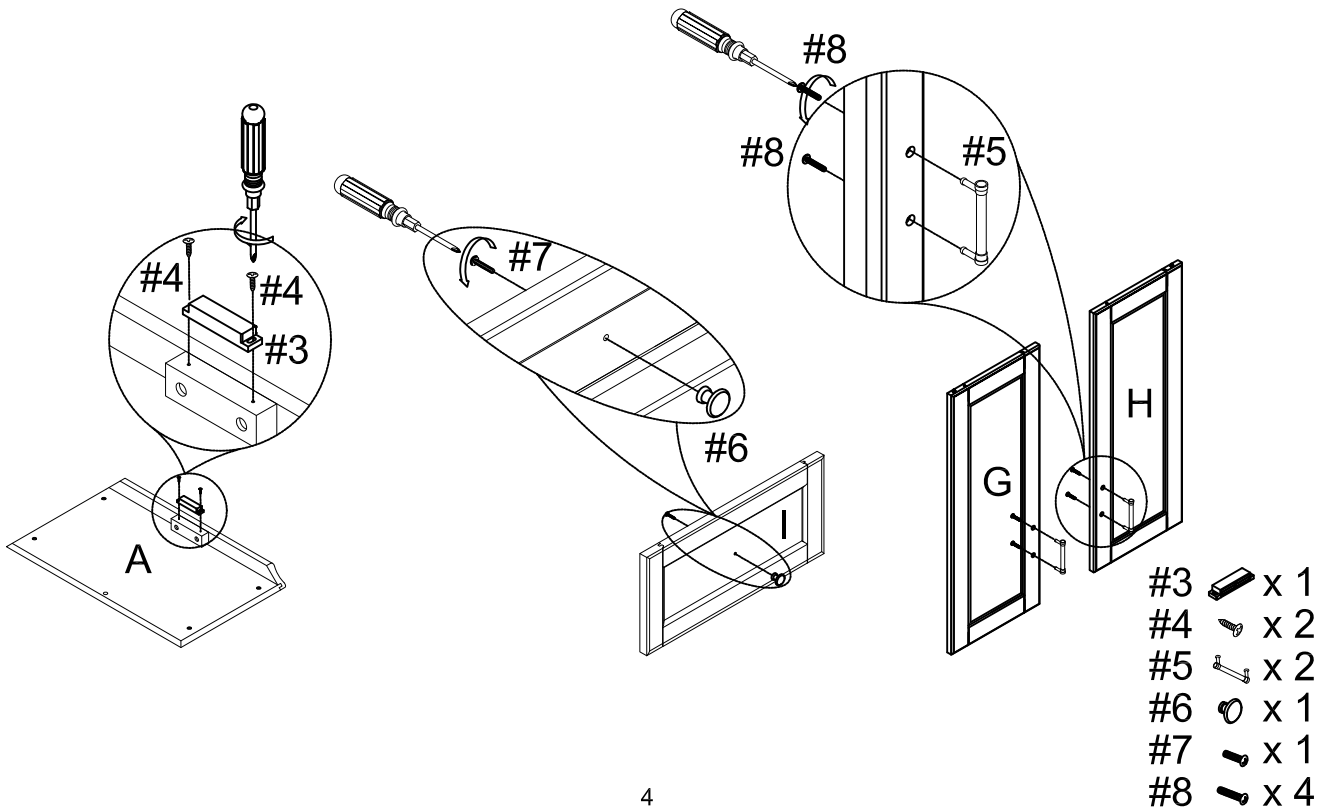

Step 2. Attach drawer left side panel (part K) and drawer right side panel (part L) to drawer back panel (part J) using small wood dowels (part #2) and lock the hardware. Slide drawer bottom panel (part M) into grooves of drawer left side panel (part K), drawer right side panel (part L) and drawer back panel (part J). Attach drawer front panel (part I) to drawer left side panel (part K), drawer right side panel (part L) and drawer bottom panel (part M) using small wood dowels (part #2) and lock the hardware.

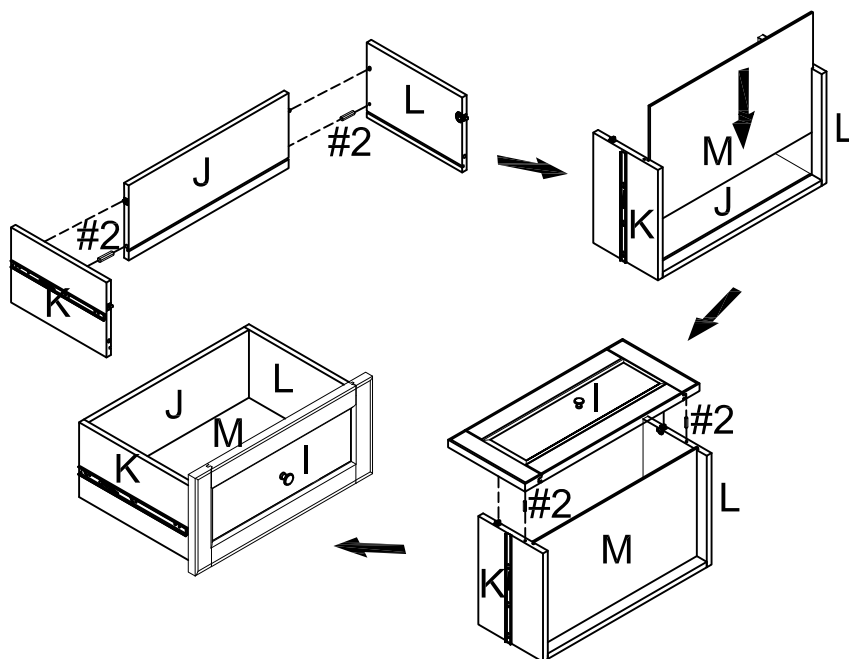

Step 3. Lay right side panel (part C) upside down on a soft surface, such as carpet, as shown below. Attach upper fixed shelf (part D) and lower fixed shelf (part E) to right side panel (part C) and lock the hardware.

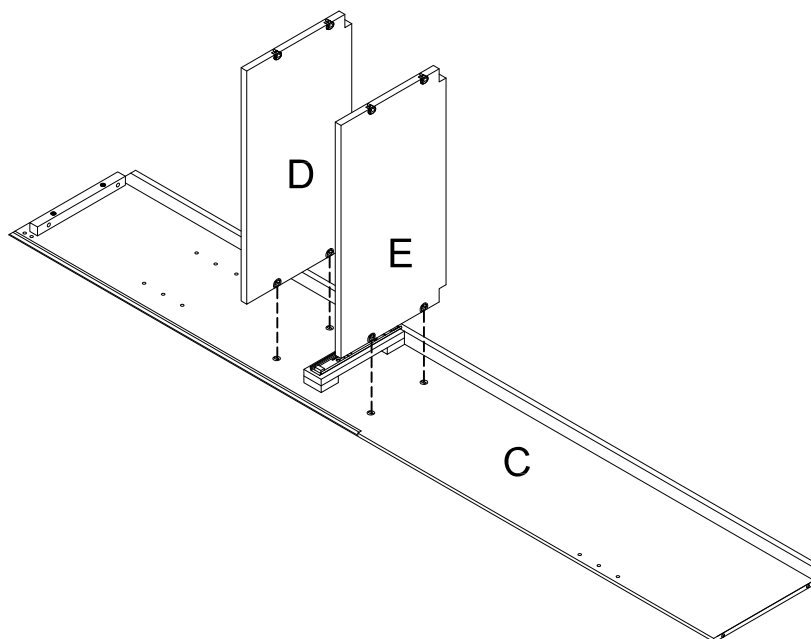



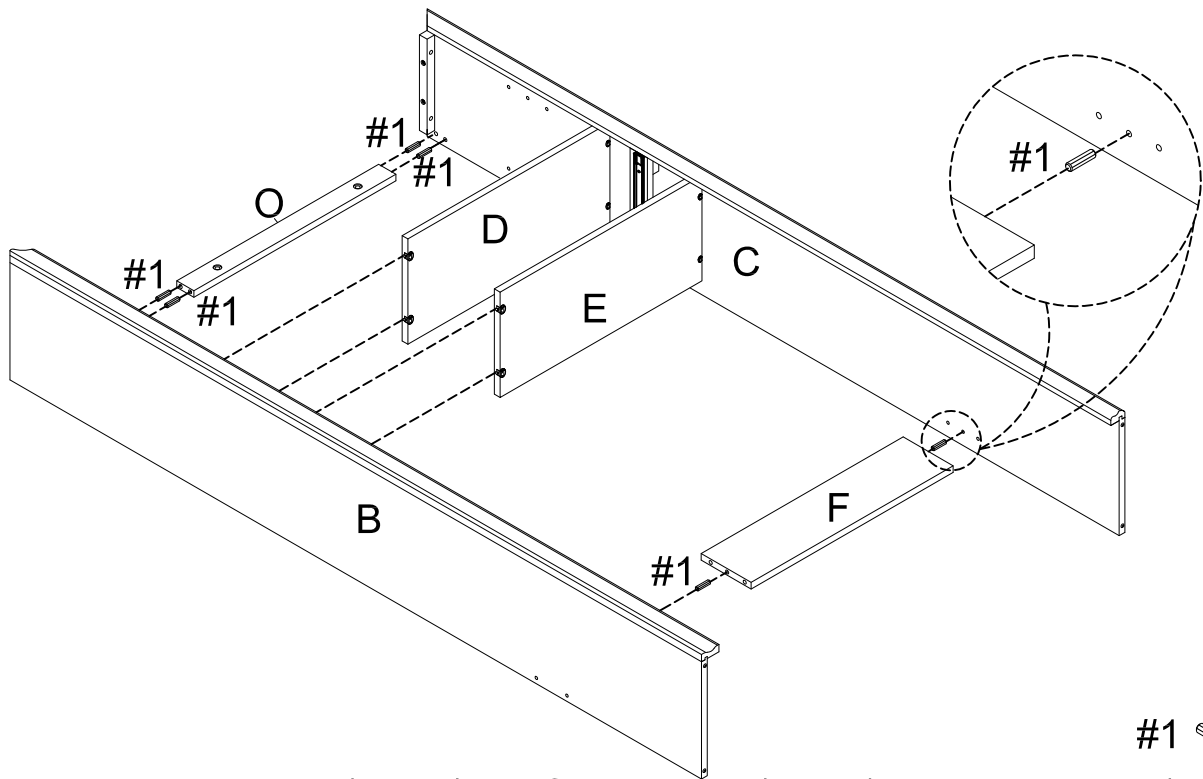

Step 4. Attach top rail (part O) and bottom rail (part F) to right side panel (part C) using large wood dowels (part #1). Attach left side panel (part B) to top rail (part O), upper fixed shelf (part D), lower fixed shelf (part E) and bottom rail (part F) using large wood dowels (part #1) and lock the hardware.

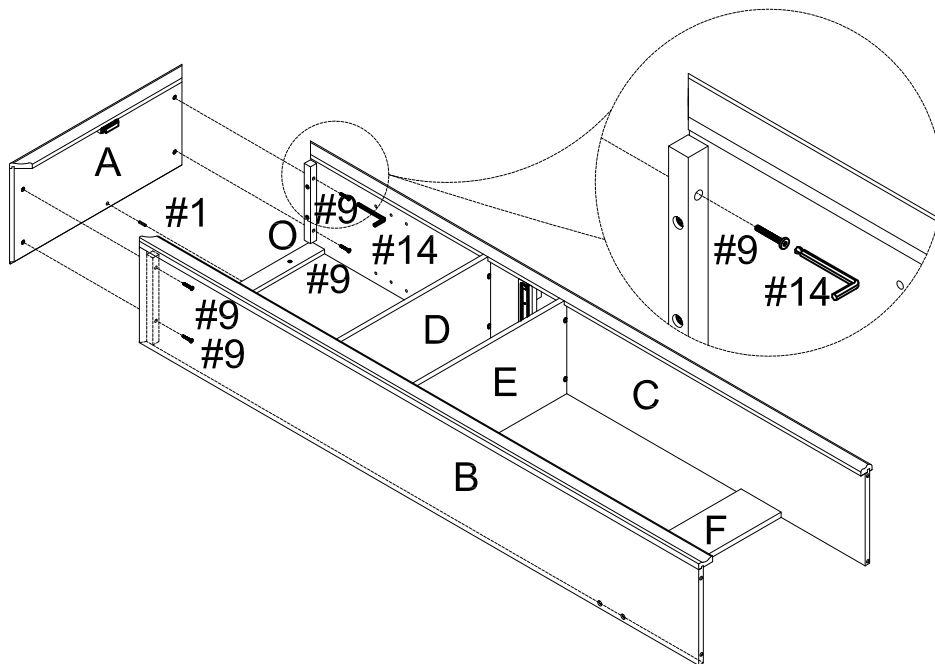

#1  x 6

Step 5. Attach top panel (part A) to left side panel (part B), right side panel (part C) and top rail (part O) using large wood dowel (part #1), short bolts (part #9) and allen wrench (part #14).



#1  x 1
 #9  x 4
 #14  x 1

Step 6. Carefully turn unit upright. Attach back panel (part N) to assembled unit (parts A, B, C, D & E) using screws (part #13) and phillips head screwdriver. Tighten bottom rail (part F) to left side panel (part B) and right side panel (part C) using barrel nuts (part #11), long bolts (part #10) and allen wrench (part #14).

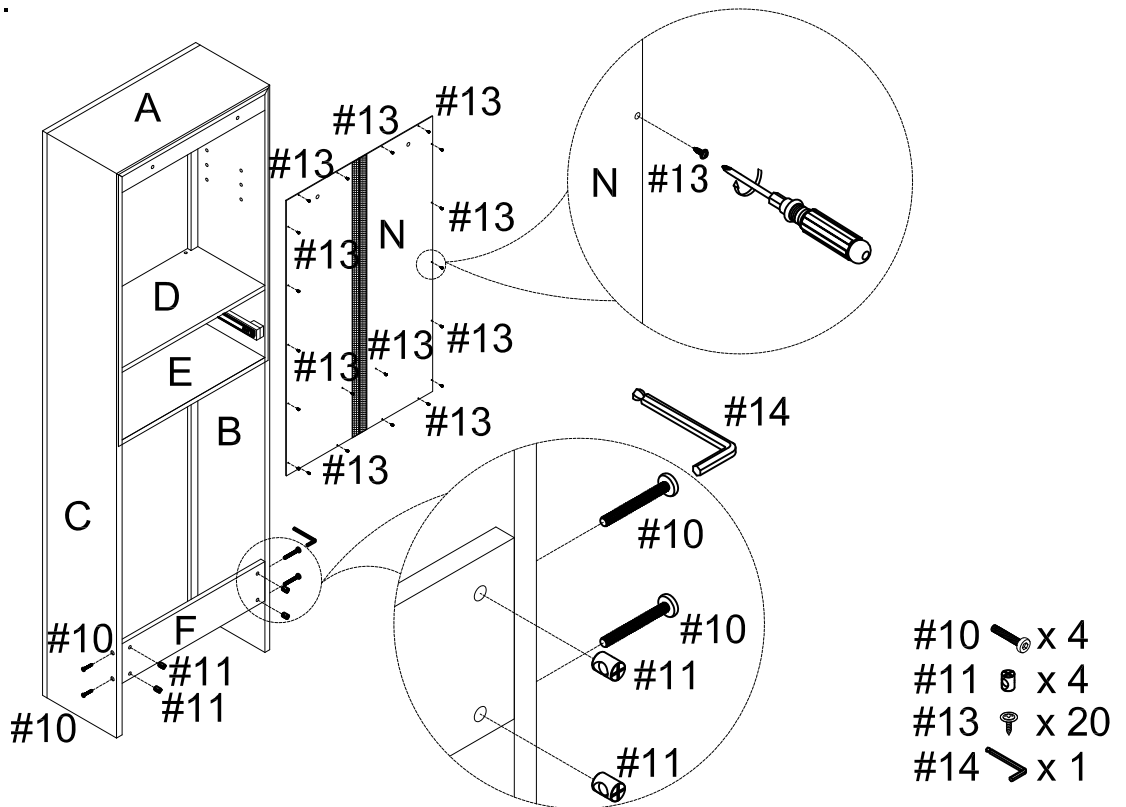

Step 7. Place shelf holders (part #12) into desired position and then slide adjustable shelf (part P) into place. Attach left door (part G) and right door (part H) by placing bottom pin hinge (pre-installed in door) in the pre-drilled hole of upper fixed shelf (part D). Then depress the top spring-loaded pin hinge so it can be placed in the pre-drilled hole of top panel (part A).

NOTE: Be sure top and bottom pin hinges are fully extended to secure doors in place.

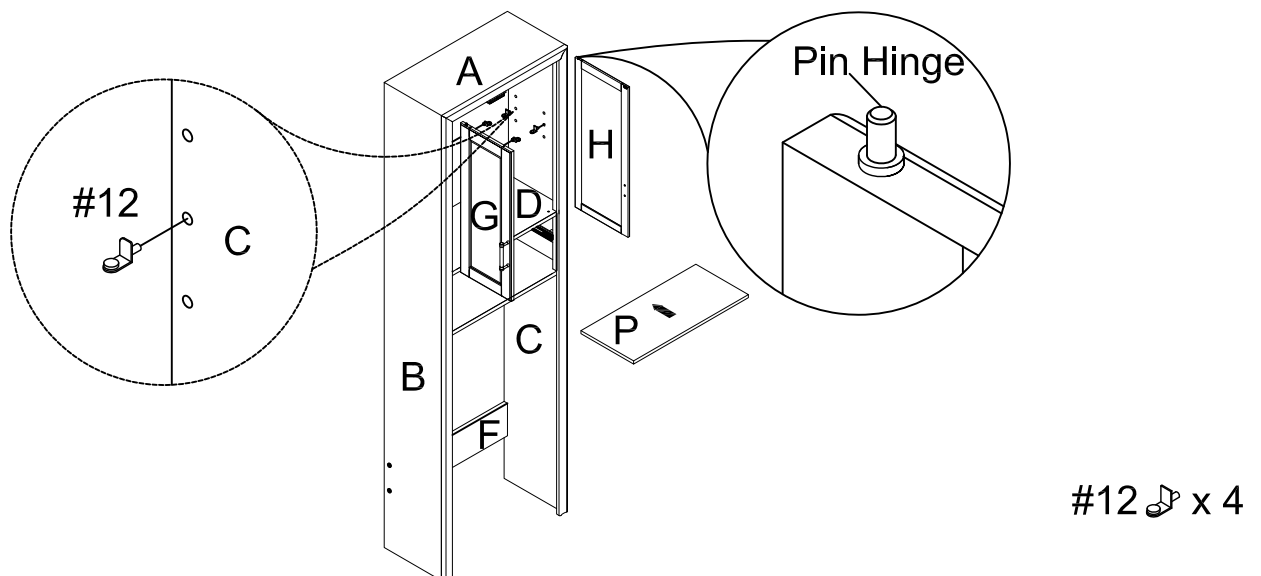

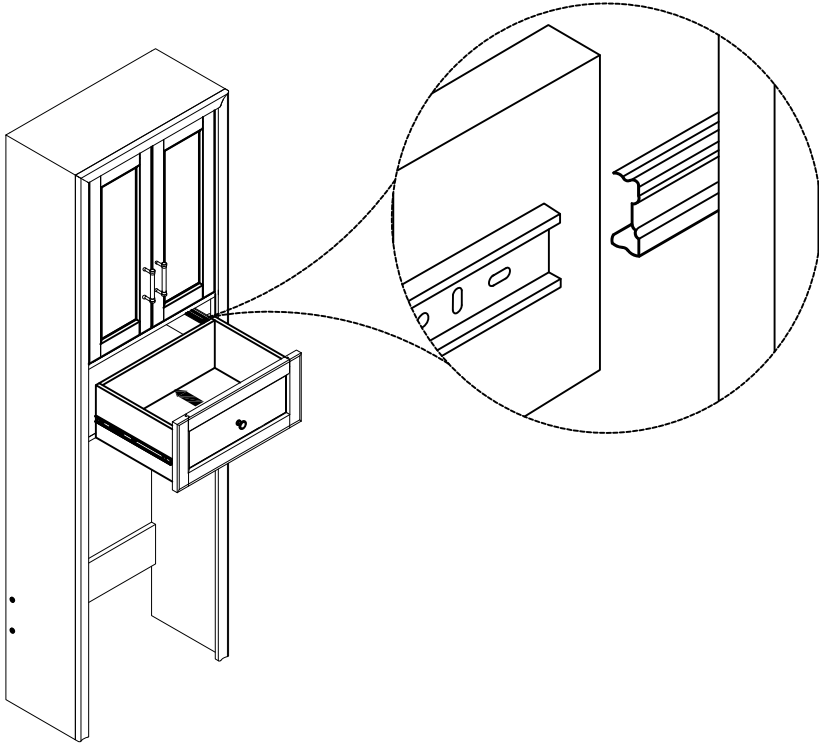

Step 8. Insert drawer into cabinet.

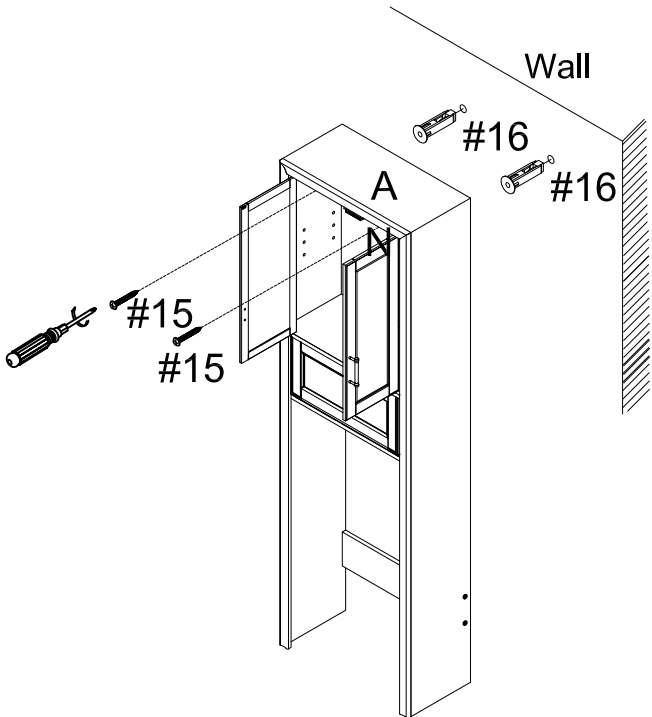

Step 9. Drill two 11/32" holes where you want to secure your cabinet. The drilled holes will be at the same height as the holes in back panel (part N). Tap wall anchors (part #16) into the holes. Secure the cabinet to the wall using long round head screws (part #15) into wall anchors (part #16) and phillips head screwdriver.



- #15  X 2
- #16  X 2