









**ASSEMBLY INSTRUCTIONS**  
**ITEM NO: DPR500RDT/ DPR300RCDB**  
**DESCRIPTION: ROUND COUNTER HEIGHT TABLE - GEMINI GRAY**

Thank you for purchasing this quality product. Be sure to check all packing material carefully for small parts that may have come loose inside the carton during shipment.

| PARTS LIST: |   |              |          |
|-------------|---|--------------|----------|
| No.         | Sketch  | Description  | Quantity |
| A           |  | Table Top    | 1 Pc     |
| B           |  | Leg          | 4 Pcs    |
| C           |  | Bottom Shelf | 1 Pc     |
| D           |  | Upper Shelf  | 1 Pc     |

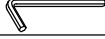
| HARDWARE LIST: |  |               |            |          |
|----------------|--|---------------|------------|----------|
| No.            | Sketch   | Description   | Size       | Quantity |
| E              |   | Washer        | 5/16"      | 12 Pcs   |
| F              |   | Spring washer | 5/16"      | 12 Pcs   |
| G              |   | Bolt          | 5/16"x45mm | 12 Pcs   |
| H              |  | Allen key     | M4         | 1 Pc     |
| I              |  | Allen key     | M4x75mm    | 1 Pc     |

**Step 1**

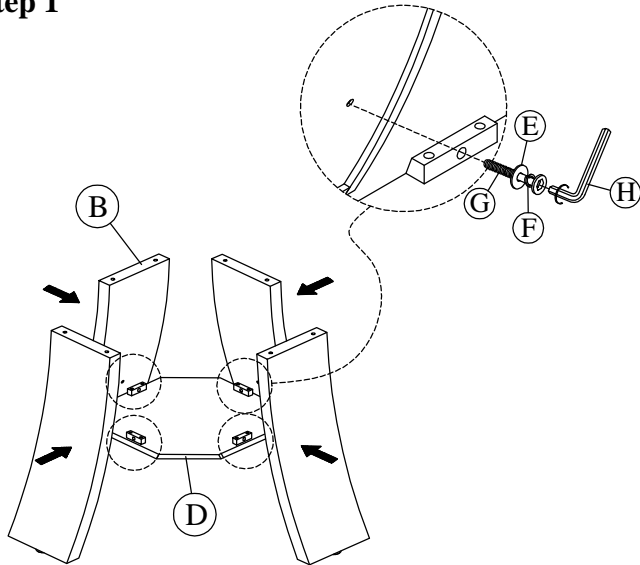

**Step 2**

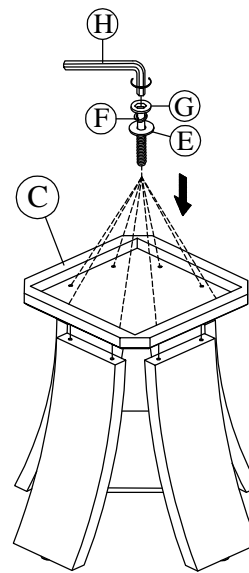

**Step 3**

Adjust the glass end to balance with the foot according to the sticker on the glass head.  
 Remove sticker after assemble done.

