

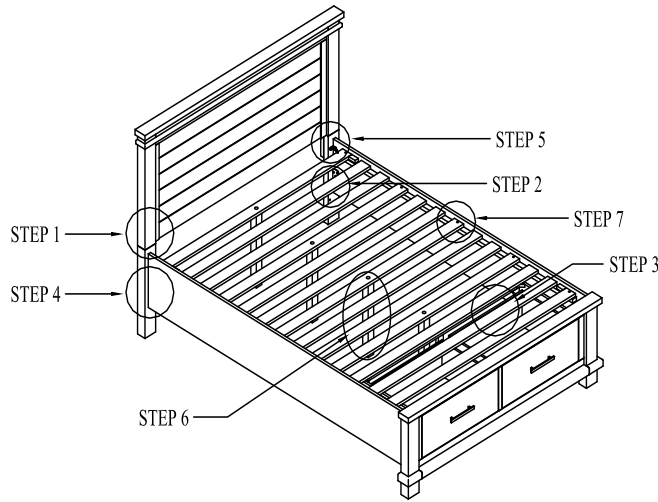







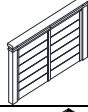

ASSEMBLY INSTRUCTIONS

ITEM NO.: 3650&3651-18H/47USF/18R
 FL PANEL HB W/STORAGE FOOTBOARD & RAILS -
 TRIBECA YTH

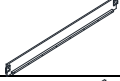
Thank you for purchasing this quality product. Be sure to check all packing material carefully for small parts that may have come loose inside the carton during shipment.

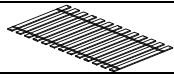
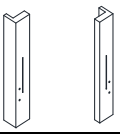

TOOLS REQUIRED (NOT PROVIDED):
 PHILLIPS SCREWDRIVER 

PARTS LIST			
NO.	DESC	SKETCH	Q'TY
A	HEADBOARD		1 PC
B	FOOTBOARD		1 PC
C	BED SIDE RAILS		2 PCS
D	CROSS BAR		1 PC
E	SLATS ROLL		1 SET
F	HEADBOARD POST (L + R)		2 PCS
G	CONNECT PANEL		2 PCS
H	SHORT SUPPORT LEG		2 PCS
I	LONG SUPPORT LEG		4 PCS

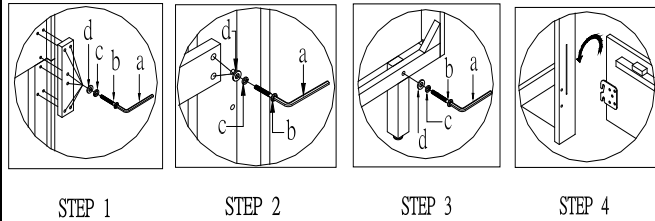

STEP 1 STEP 2 STEP 3 STEP 4

HARDWARE LIST FOR HEADBOARD				
NO.	DESCRIPTION	SKETCH	SIZE	Q'TY
a	Allen Key		4 x 74 x 29mm	1 PC
b	Bolt		ϕ 1/4" x 15 x 38mm	16 PCS
c	Spring Washer		ϕ 1/4" x ϕ 11 x 2mm T	16 PCS
d	Flat Washer		ϕ 1/4" x ϕ 18 x 2mm T	16 PCS
g	Straight Allen Key		4*100mm	1 PC

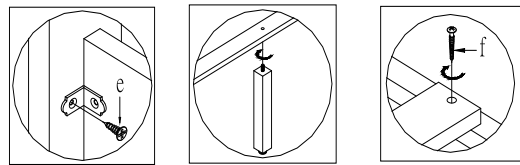

STEP 5 STEP 6 STEP 7

HARDWARE LIST FOR FOOTBOARD				
NO.	DESCRIPTION	SKETCH	SIZE	Q'TY
a	Allen Key		4 x 74 x 29mm	1 PC
b	Bolt		ϕ 1/4" x 15 x 38mm	2 PCS
c	Spring Washer		ϕ 1/4" x ϕ 11 x 2mm T	2 PCS
d	Flat Washer		ϕ 1/4" x ϕ 18 x 2mm T	2 PCS
e	Screw		#6 x 15mm	4 PCS
f	Screw		#8x30mm	10 PC
g	Straight Allen Key		4x100mm	1 PC

- STEP 1: ATTACH CONNECT PANEL (G) TO HEADBOARD POST (F) AND HEADBOARD (A) BY USING ALLEN KEY (a), BOLT (b), SPRING WASHER (c) AND FLAT WASHER (d).
 STEP 2: ATTACH CROSS BAR (D) TO THE HEADBOARD POST (F) BY USING ALLEN KEY (a), BOLT (b), SPRING WASHER (c) AND FLAT WASHER (d).
 STEP 3: ATTACH SHORT SUPPORT LEGS (H) TO THE STORAGE FOOTBOARD (B) BY USING ALLEN KEY (a), BOLT (b), SPRING WASHER (c), FLAT WASHER (d).
 STEP 4: HANG SIDE RAILS (C) TO THE HEADBOARD POST (F) AND FOOTBOARD (B).
 STEP 5: SECURE SIDE RAILS (C) WITH HEADBOARD POST (F) BY USING SCREW (e).
 STEP 6: ATTACH LONG SUPPORT LEG (I) TO SLATS ROLL (E) BY TURNING CLOCKWISE.
 STEP 7: ATTACH SLATS (E) TO SIDE RAILS (C) BY USING SCREW (f).

IMPORTANT NOTE:

- HARDWARE BAG FOR HEADBOARD IS PACKED WITH HEADBOARD.
- HARDWARE BAG FOR FOOTBOARD AND SLATS IS PACKED WITH FOOTBOARD.

Made In Vietnam