

# ASSEMBLY INSTRUCTIONS

ITEM NO.: 3650&3651-47H/47USF/18R

FL BOOKCASE BED W/STORAGE FOOTBOARD & RAILS -  
TRIBECA YTH

Thank you for purchasing this quality product. Be sure to check all packing material carefully for small parts that may have come loose inside the carton during shipment.

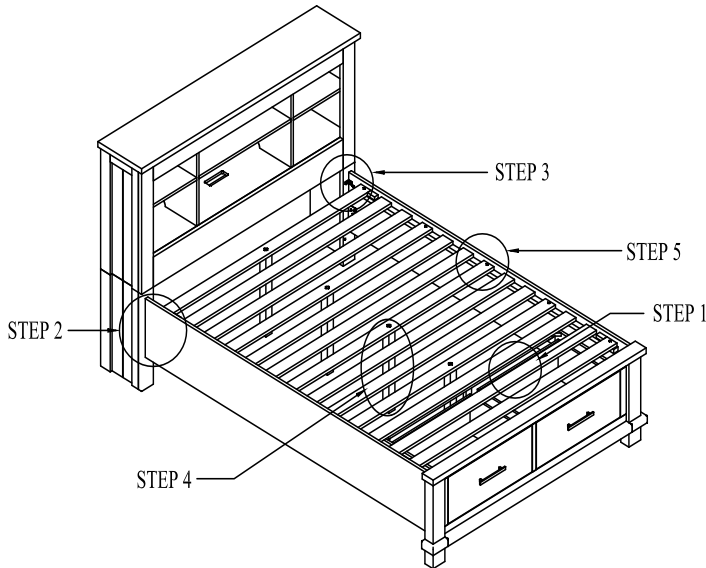

TOOLS REQUIRED (NOT PROVIDED):  
PHILLIPS SCREWDRIVER

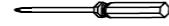

## PARTS LIST

NO.	DESC	SKETCH	Q'TY
A	BOOKCASE HEADBOARD		1 PC
B	STORAGE FOOTBOARD		1 PC
C	BED SIDE RAILS		2 PCS
D	BED SLATS ROLL		1 SET
E	SHORT SUPPORT LEG		2 PCS
F	LONG SUPPORT LEG		4 PCS

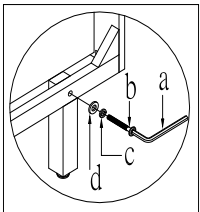

STEP 1

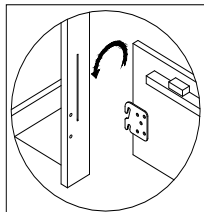

STEP 2

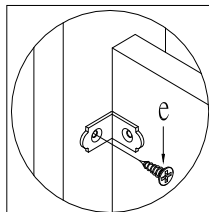

STEP 3

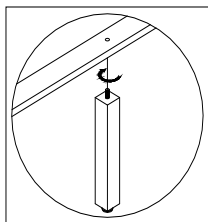

STEP 4

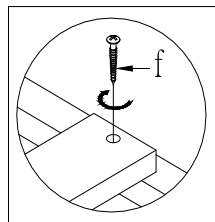

STEP 5

## HARDWARE LIST FOR FOOTBOARD

NO.	DESCRIPTION	SKETCH	SIZE	Q'TY
a	Allen Key		4 x 74 x 29mm	1 PC
b	Bolt		ϕ 1/4" x 15 x 38mm	2 PCS
c	Spring Washer		ϕ1/4" x ϕ11 x 2mm T	2 PCS
d	Flat Washer		ϕ1/4" x ϕ18 x 2mm T	2 PCS
e	Screw		#6*15mm	4 PCS
f	Screw		#8*30mm	10 PC
g	STRAIGHT ALLEN KEY		4*100mm	1 PC

- STEP 1: ATTACH SUPPORT LEGS ( E ) TO THE STORAGE FOOTBOARD ( B ) BY USING ALLEN KEY ( a ), BOLT ( b ), SPRING WASHER ( c ), FLAT WASHER ( d ).  
 STEP 2: HANG SIDE RAILS ( C ) TO THE BOOKCASE HEADBOARD ( A ) AND STORAGE FOOTBOARD ( B ).  
 STEP 3: SECURE SIDE RAILS ( C ) WITH BOOKCASE HEADBOARD ( A ) BY USING SCREW ( e ).  
 STEP 4: ATTACH LONG SUPPORT LEG ( F ) TO SLATS ROLL ( D ) BY TURNING CLOCKWISE.  
 STEP 5: ATTACH SLATS ROLL ( D ) TO SIDE RAILS ( C ) BY USING SCREW ( f ).

**IMPORTANT NOTE:**

- HARDWARE BAG FOR HEADBOARD IS PACKED WITH HEADBOARD.
- HARDWARE BAG FOR FOOTBOARD AND SLATS IS PACKED WITH FOOTBOARD.

Made In Vietnam