



ASSEMBLY INSTRUCTIONS

ITEM NO.: 2650-21H/21USF/27R

QUEEN BED W/STORAGE FOOTBOARD & HIGH RAILS

Thank you for purchasing this quality product. Be sure to check all packing material carefully for small parts that may have come loose inside the carton during shipment.

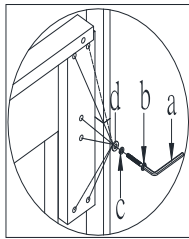
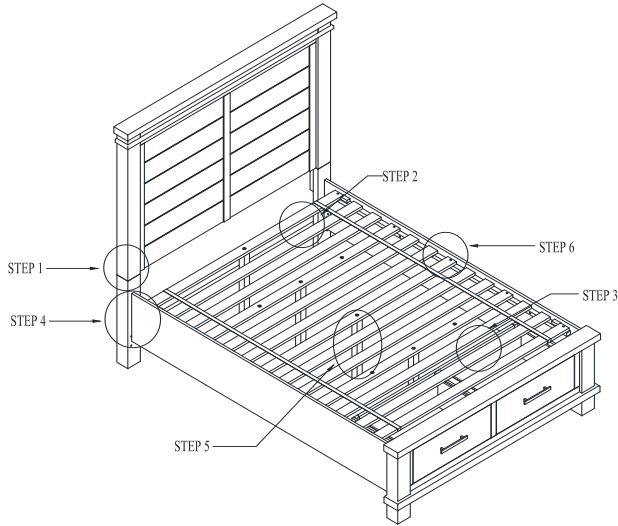

STEP 1

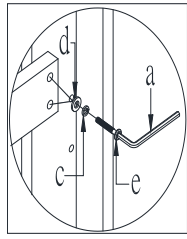

STEP 2

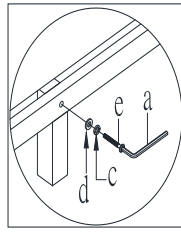

STEP 3

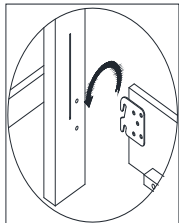

STEP 4

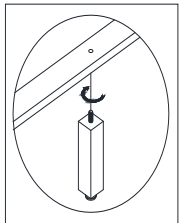



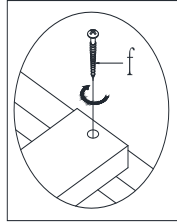





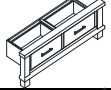



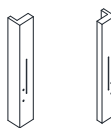

STEP 5









STEP 6

TOOLS REQUIRED (NOT PROVIDED):
PHILLIPS SCREWDRIVER 

PARTS LIST			
NO.	DESC	SKETCH	Q'TY
A	HEADBOARD		1 PC
B	FOOTBOARD		1 PC
C	BED HIGH RAILS		2 PCS
D	CROSS BAR		1 PC
E	BED SLATS		4 PCS
F	HEADBOARD POST (L + R)		2 PCS
G	LONG SUPPORT LEG		4 PCS
H	CONNECT PANEL		2 PCS
I	SHORT SUPPORT LEG		2PCS

HARDWARE LIST FOR HEADBOARD				
NO.	DESCRIPTION	SKETCH	SIZE	Q'TY
a	Allen Key		4 x 74 x 29mm	1 PC
b	Bolt		ϕ1/4" x 15 x 45mm	12 PCS
c	Spring Washer		ϕ1/4" x ϕ11 x 2mm T	16 PCS
d	Flat Washer		ϕ1/4" x ϕ18 x 2mm T	16 PCS
e	Bolt		ϕ1/4" x 15 x 38mm	4 PCS
g	STRAIGHT ALLEN KEY		4*100mm	1 PC

HARDWARE LIST FOR FOOTBOARD AND SLATS				
NO.	DESCRIPTION	SKETCH	SIZE	Q'TY
a	Allen Key		4 x 74 x 29mm	1 PC
c	Spring Washer		ϕ1/4" x ϕ11 x 2mm T	2 PCS
d	Flat Washer		ϕ1/4" x ϕ18 x 2mm T	2 PCS
e	Bolt		ϕ1/4" x 15 x 38mm	2 PCS
f	Screw		#8 x 30mm	10 PCS
g	STRAIGHT ALLEN KEY		4*100mm	1 PC

- STEP 1: ATTACH CONNECT PANEL (H) TO HEADBOARD POST (F) AND HEADBOARD (A) BY USING ALLEN KEY (a), BOLT (b), SPRING WASHER (c) AND FLAT WASHER (d).
 STEP 2: ATTACH CROSS BAR (D) TO THE HEADBOARD POST (F) BY USING ALLEN KEY (a), BOLT (e), SPRING WASHER (c) AND FLAT WASHER (d).
 STEP 3: ATTACHED SHORT SUPPORT LEG (I) TO THE FOOTBOARD (B) BY USING ALLEN KEY (a), BOLT (e), SPRING WASHER (c) AND FLAT WASHER (d).
 STEP 4: HANG SIDE RAILS (C) TO THE HEADBOARD POST (F) AND FOOTBOARD (B).
 STEP 5: ATTACH SUPPORT LEG (G) TO SLATS (E) BY TURNING CLOCKWISE.
 STEP 6: ATTACH SLATS (E) TO SIDE RAILS (C) BY USING SCREW (f).

IMPORTANT NOTE:

- HARDWARE BAG FOR HEADBOARD IS PACKED WITH HEADBOARD.
- HARDWARE BAG FOR FOOTBOARD AND SLATS IS PACKED WITH FOOTBOARD.

Made In Vietnam



ASSEMBLY INSTRUCTIONS

ITEM NO.: 2650-36
NIGHT STAND

THANK YOU FOR PURCHASING THIS QUALITY PRODUCT. BE SURE TO CHECK ALL PACKING MATERIAL CAREFULLY FOR SMALL PARTS THAT MAY HAVE COME LOOSE INSIDE THE CARTON DURING SHIPMENT.

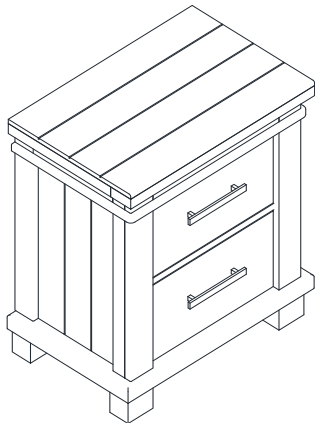
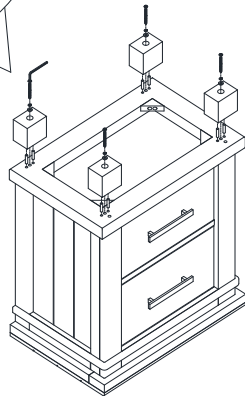
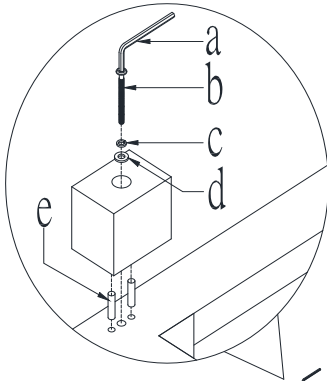

TOOLS REQUIRED (NOT PROVIDED)

PHILLIPS SCREWDRIVER



PARTS LIST:

NO	DESCRIPTION	SKETCH	QTY
A	NIGHT STAND		1 PC
B	BUN FEET		4 PCS

HARDWARE LIST:

NO	DESCRIPTION	SKETCH	SIZE	QTY
a	Allen Key		4 x 74 x 29mm	1 PC
b	Bolt		ϕ 1/4"x 15 x 70mm	4 PCS
c	Spring Washer		ϕ 1/4"x ϕ 11x 2mm T	4 PCS
d	Flat Washer		ϕ 1/4"x ϕ 18 x 2mm T	4 PCS
e	WOODEN DOWEL		10*40mm	8 PCS
f	STRAIGHT ALLEN KEY		4*100mm	1PC
g	TIPPING RESTRAINT			1 set

STEP 1: Lay the night stand (A) up side down on a soft surface. Insert wooden dowel (e) to the bottom of night stand (A). Attach bun feet (B) by using allen key (a), bolt (b), spring washer (c), flat washer (d).

Important note:

The hardware bag is packed with NIGHT STAND.



ASSEMBLY INSTRUCTIONS

ITEM NO.: 2650-01&02

DRAWER DRESSER & LANDSCAPE MIRROR

THANK YOU FOR PURCHASING THIS QUALITY PRODUCT. BE SURE TO CHECK ALL PACKING MATERIALS CAREFULLY FOR SMALL PARTS THAT MAY HAVE COME LOOSE INSIDE THE CARTON DURING SHIPMENT.

TOOLS REQUIRED (NOT PROVIDED)

PHILLIPS SCREWDRIVER



PARTS LIST:

NO	DESCRIPTION	SKETCH	QTY
A	DRAWER DRESSER		1 PC
B	BUN FEET		4 PCS
C	CENTER SUPPORT LEG		1 PC
D	LANDSCAPE MIRROR		1 PC
E	MIRROR SUPPORT		2 PCS

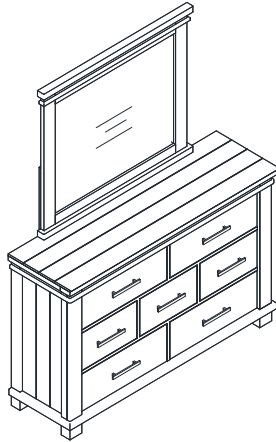

DRAWER DRESSER HARDWARE LIST:

NO	DESCRIPTION	SKETCH	SIZE	QTY
a	Allen Key		4 x 74 x 29mm	1 PC
b	Bolt		ϕ 1/4"x 15 x 70mm	4 PCS
c	Spring Washer		ϕ 1/4"x ϕ 11x 2mm T	4 PCS
d	Flat Washer		ϕ 1/4"x ϕ 18 x 2mm T	4 PCS
e	WOODEN DOWEL		10*40mm	8 PCS
f	TIPPING RESTRAINT			1 set
g	STRAIGHT ALLEN KEY		4*100mm	1PC

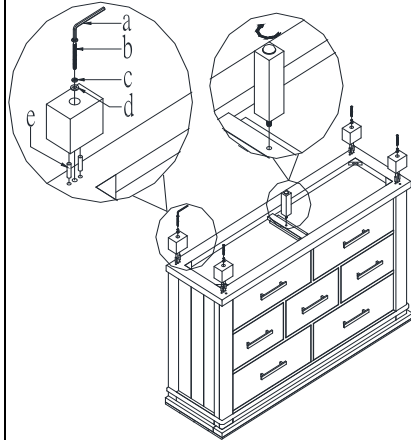

LANDSCAPE MIRROR HARDWARE LIST:

NO	DESCRIPTION	SKETCH	SIZE	QTY
a	Allen Key		4 x 74 x 29mm	1 PC
h	Bolt		ϕ 1/4"x 11.5 x 32mm	8 PCS
c	Spring Washer		ϕ 1/4"x ϕ 11x 2mm T	8 PCS
d	Flat Washer		ϕ 1/4"x ϕ 18 x 2mm T	8 PCS
g	STRAIGHT ALLEN KEY		4*100mm	1PC

STEP 1: Lay the drawer dresser (A) up side down on a soft surface. Insert wooden dowel (e) to the bottom of drawer dresser (A). Attach bun feet(B) by using allen key (a), bolt (b), spring washer (c), flat washer (d). Attach center support leg (C) to the bottom of drawer dresser (A).

STEP 2: With another person's assistance, lift the mirror (D) and attach mirror support (E) into position on top of the dresser. Secure the mirror in place by using allen key (a), bolt (h), spring washer (c), flat washer (d).

Important note:

1. The furniture tipping restraint is stapled to the back of the dresser.
2. The hardware bag for the Drawer Dresser is packed with Drawer Dresser.
3. The hardware bag for the Landscape Mirror is packed with Landscape Mirror.

