



ASSEMBLY INSTRUCTIONS

ITEM NO.: 2650-21H/21USF/27R

QUEEN BED W/STORAGE FOOTBOARD & HIGH RAILS

Thank you for purchasing this quality product. Be sure to check all packing material carefully for small parts that may have come loose inside the carton during shipment.

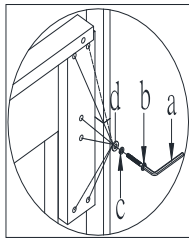
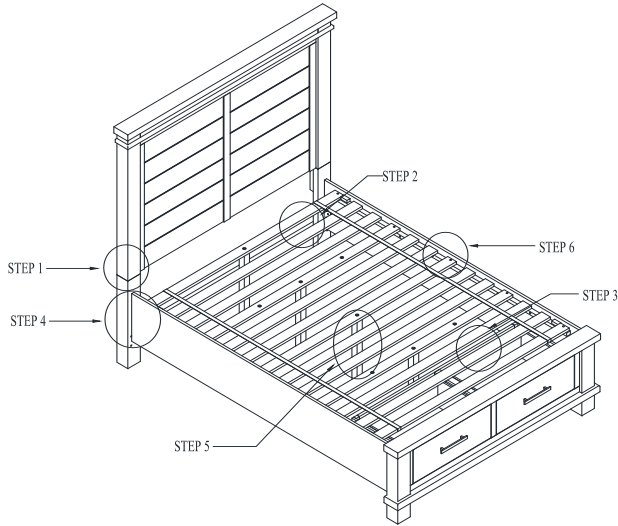

STEP 1

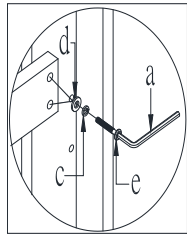

STEP 2

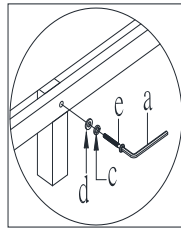

STEP 3

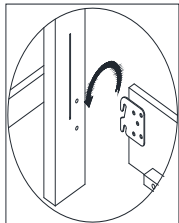

STEP 4

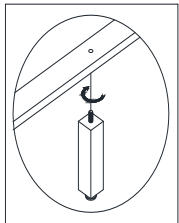



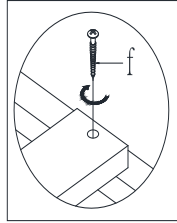





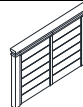
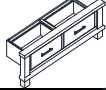



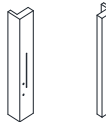

STEP 5









STEP 6

TOOLS REQUIRED (NOT PROVIDED):
PHILLIPS SCREWDRIVER 

PARTS LIST			
NO.	DESC	SKETCH	Q'TY
A	HEADBOARD		1 PC
B	FOOTBOARD		1 PC
C	BED HIGH RAILS		2 PCS
D	CROSS BAR		1 PC
E	BED SLATS		4 PCS
F	HEADBOARD POST (L + R)		2 PCS
G	LONG SUPPORT LEG		4 PCS
H	CONNECT PANEL		2 PCS
I	SHORT SUPPORT LEG		2PCS

HARDWARE LIST FOR HEADBOARD				
NO.	DESCRIPTION	SKETCH	SIZE	Q'TY
a	Allen Key		4 x 74 x 29mm	1 PC
b	Bolt		ϕ1/4" x 15 x 45mm	12 PCS
c	Spring Washer		ϕ1/4" x ϕ11 x 2mm T	16 PCS
d	Flat Washer		ϕ1/4" x ϕ18 x 2mm T	16 PCS
e	Bolt		ϕ1/4" x 15 x 38mm	4 PCS
g	STRAIGHT ALLEN KEY		4*100mm	1 PC

HARDWARE LIST FOR FOOTBOARD AND SLATS				
NO.	DESCRIPTION	SKETCH	SIZE	Q'TY
a	Allen Key		4 x 74 x 29mm	1 PC
c	Spring Washer		ϕ1/4" x ϕ11 x 2mm T	2 PCS
d	Flat Washer		ϕ1/4" x ϕ18 x 2mm T	2 PCS
e	Bolt		ϕ1/4" x 15 x 38mm	2 PCS
f	Screw		#8 x 30mm	10 PCS
g	STRAIGHT ALLEN KEY		4*100mm	1 PC

- STEP 1: ATTACH CONNECT PANEL (H) TO HEADBOARD POST (F) AND HEADBOARD (A) BY USING ALLEN KEY (a), BOLT (b), SPRING WASHER (c) AND FLAT WASHER (d).
 STEP 2: ATTACH CROSS BAR (D) TO THE HEADBOARD POST (F) BY USING ALLEN KEY (a), BOLT (e), SPRING WASHER (c) AND FLAT WASHER (d).
 STEP 3: ATTACHED SHORT SUPPORT LEG (I) TO THE FOOTBOARD (B) BY USING ALLEN KEY (a), BOLT (e), SPRING WASHER (c) AND FLAT WASHER (d).
 STEP 4: HANG SIDE RAILS (C) TO THE HEADBOARD POST (F) AND FOOTBOARD (B).
 STEP 5: ATTACH SUPPORT LEG (G) TO SLATS (E) BY TURNING CLOCKWISE.
 STEP 6: ATTACH SLATS (E) TO SIDE RAILS (C) BY USING SCREW (f).

IMPORTANT NOTE:

- HARDWARE BAG FOR HEADBOARD IS PACKED WITH HEADBOARD.
- HARDWARE BAG FOR FOOTBOARD AND SLATS IS PACKED WITH FOOTBOARD.

Made In Vietnam