

ASSEMBLY INSTRUCTIONS

ITEM NO.: 2638-29H/29F/29R
QUEEN BED W/REGULAR FOOTBOARD & RAILS - HANOVER

Thank you for purchasing this quality product. Be sure to check all packing material carefully for small parts that may have come loose inside the carton during shipment.

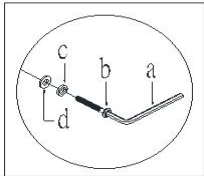
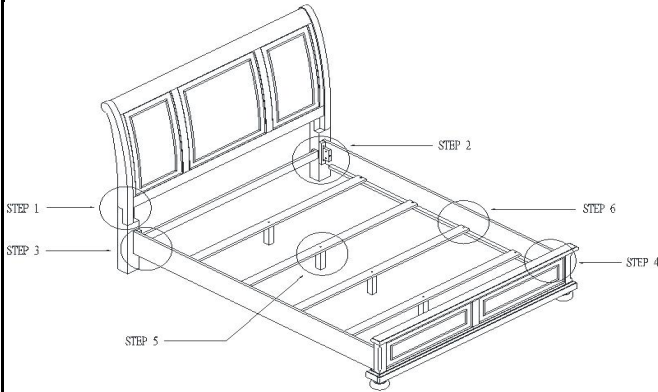

STEP 1

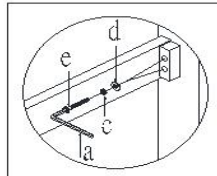

STEP 2

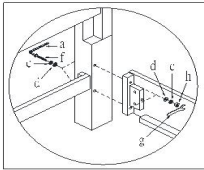

STEP 3

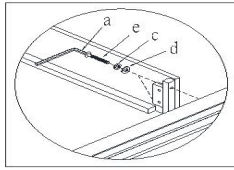

STEP 4

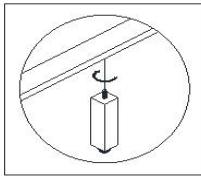

STEP 5

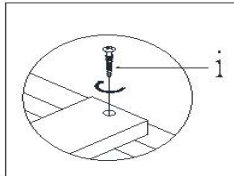

STEP 6

- STEP 1: ATTACH HEADBOARD POST (F) TO THE HEADBOARD (A) BY USING ALLEN KEY (a), BOLT (b), SPRING WASHER (c) AND FLAT WASHER (d).
 STEP 2: ATTACH CROSS BAR (D) TO THE HEADBOARD POST (F) BY USING ALLEN KEY (a), BOLT (e), SPRING WASHER (c) AND FLAT WASHER (d).
 STEP 3: ATTACH SIDE RAILS (C) TO THE HEADBOARD POST (F) BY USING ALLEN KEY (a), BOLT (f), SPRING WASHER (c), FLAT WASHER (d), WRENCH (g) AND HEX NUT (h).
 STEP 4: ATTACH SIDE RAILS (C) TO THE FOOTBOARD (B) BY USING ALLEN KEY (a), BOLT (e), SPRING WASHER (c) AND FLAT WASHER (d).
 STEP 5: ATTACH SUPPORT LEG (G) TO SLATS (E) BY TURNING COUNTERCLOCKWISE.
 STEP 6: ATTACH SLATS (E) TO SIDE RAILS (C) BY USING SCREW (i).

IMPORTANT NOTE:

- HARDWARE BAG FOR HEADBOARD IS PACKED WITH HEADBOARD.
- HARDWARE BAG FOR FOOTBOARD AND RAILS IS PACKED WITH FOOTBOARD.

Made In Vietnam

TOOLS REQUIRED (NOT PROVIDED):
PHILLIPS SCREWDRIVER



PARTS LIST

NO.	DESC	SKETCH	QTY
A	HEADBOARD		1 PC
B	FOOTBOARD		1 PC
C	BED SIDE RAILS		2 PCS
D	CROSS BAR		1 PC
E	BED SLATS		4 PCS
F	HEADBOARD POST (L + R)		2 PCS
G	SUPPORT LEG		4 PCS

HARDWARE LIST FOR HEADBOARD

NO.	DESCRIPTION	SKETCH	SIZE	QTY
a	Allen Key		4 x 74 x 29mm	1 PC
b	Bolt		1/4" x 11.5 x 50mm	4 PCS
c	Spring Washer		1/4" x 11 x 2mm T	8 PCS
d	Flat Washer		1/4" x 18 x 2mm T	8 PCS
e	Bolt		1/4" x 11.5 x 38mm	4 PCS
j	STRAIGHT ALLEN KEY		4*100mm	1 PC

HARDWARE LIST FOR FOOTBOARD AND RAILS

NO.	DESCRIPTION	SKETCH	SIZE	QTY
a	Allen Key		4 x 74 x 29mm	1 PC
c	Spring Washer		1/4" x 11 x 2mm T	12 PCS
d	Flat Washer		1/4" x 18 x 2mm T	12 PCS
e	Bolt		1/4" x 11.5 x 38mm	4 PCS
f	Bolt		1/4" x 11.5 x 125mm	4 PCS
g	Wrench			1 PC
h	Hex Nut		1/4" x 10mm	4 PCS
i	Screw		#8 x 30mm	8 PCS
j	STRAIGHT ALLEN KEY		4*100mm	1 PC