

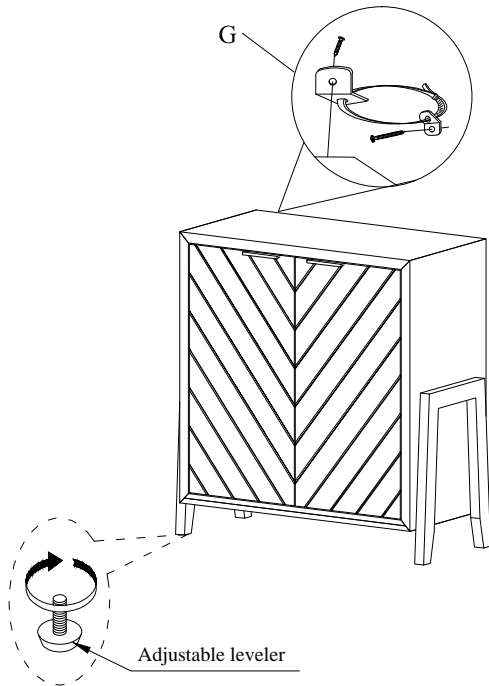

**ASSEMBLY INSTRUCTIONS**  
**ITEM NO:81678**  
**ACCENT CASE-ELI IVORY**







Thank you for purchasing this quality product. Be sure to check all packing material carefully for small parts that may have come loose inside the carton during shipment.



**PARTS LIST:**

No.	Description	Sketch	Quantity
A	ACCENT CASE		1PC
B	LEG		2PCS

**HARDWARE LIST:**

No.	Description	Sketch	Size	Quantity
C	Bolt		Ø5/16"*1-5/8"	8PCS
D	Spring Washer		Ø5/16"*3/4"	8PCS
E	Flat Washer		Ø5/16"*1/2"	8PCS
F	Allen key		M5*65L	1PC
G	Furniture tipping restraint			1SET
H	Straight Allen key		M5*100mmL	1PC

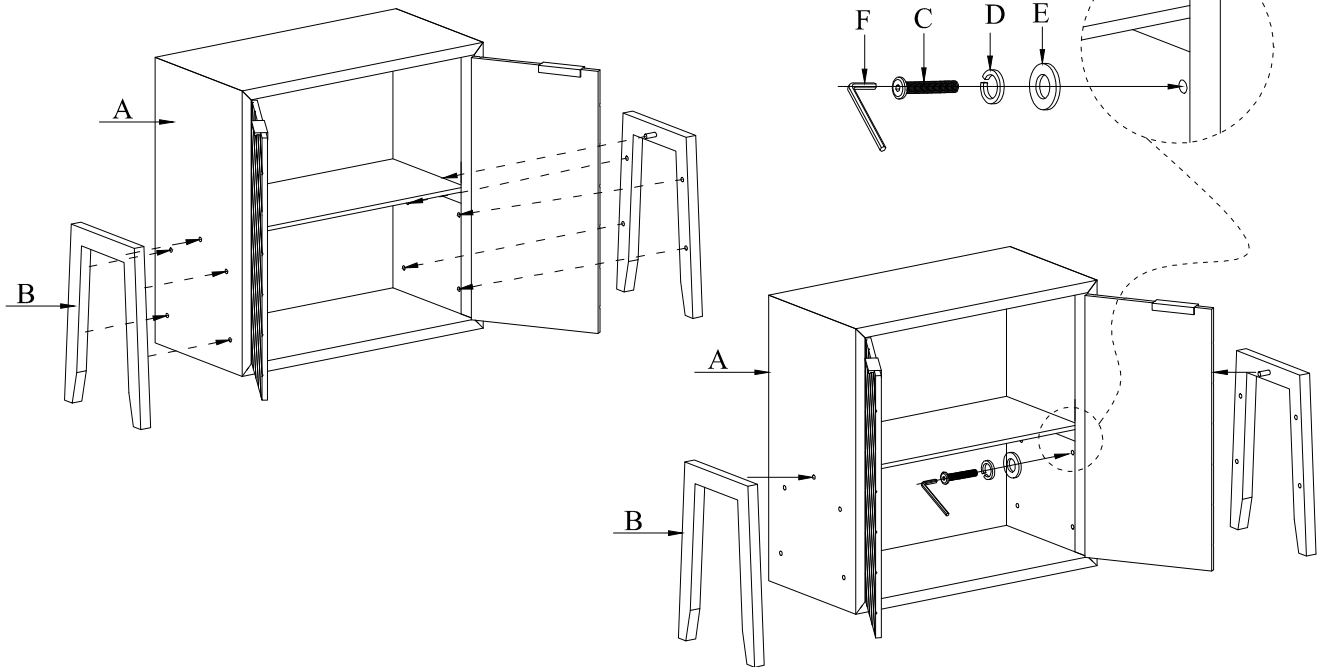

NOTE: 1.THE FURNITURE TIPPING RESTRAINT IS STAPLED TO THE BACK OF THE UNIT.  
 2.STRAIGHT ALLEN KEY(H)IS FOR USE WITH A POWER DRILL.