

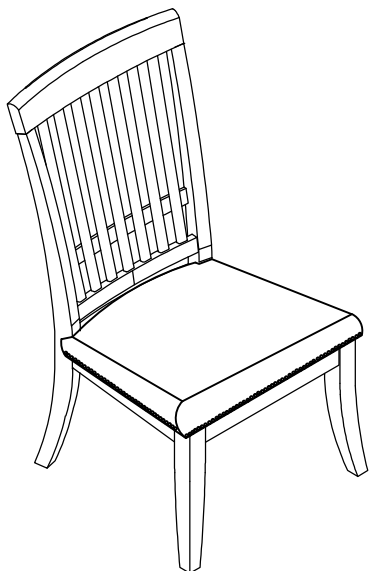



ASSEMBLY INSTRUCTIONS









Item No: 290202-2802/2817/2804& 290202-2817SP

Description: SLAT BACK SIDE CHAIR-LANCASTER

Thank you for purchasing this quality product. Be sure to check all packing material carefully for small parts that may have come loose inside the carton during shipment.

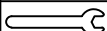

PARTS LIST:			
No.	Description	Sketch	Quantity
A	Chair back		1PC
B	Front Legs		2PCS
C	Seat Frame & Cushion		1PC

HARDWARE LIST:				
No.	Description	Sketch	Size	Quantity
D	Bolt		$\frac{5}{16}$ " x $1\frac{3}{4}$ "	2PCS
E	Lock washer		$\frac{5}{16}$ "	10PCS
F	Flat washer		$\frac{5}{16}$ "	10PCS
G	Bolt		$\frac{5}{16}$ " x $3\frac{1}{4}$ "	4PCS
H	Spanner		13mm	1PC
I	Nut		$\frac{5}{16}$ "	4PC
J	Allen Wrench		5mm	1PC
K	Straight allen wrench		5mm	1PC

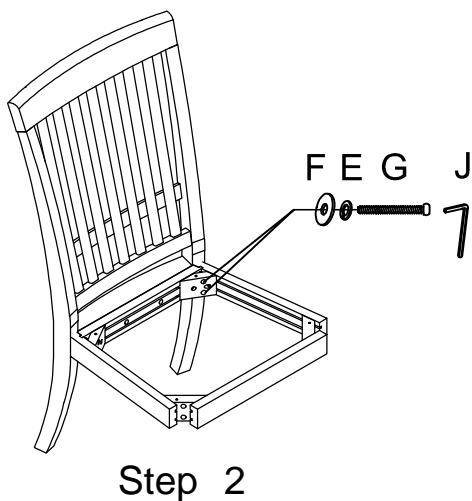
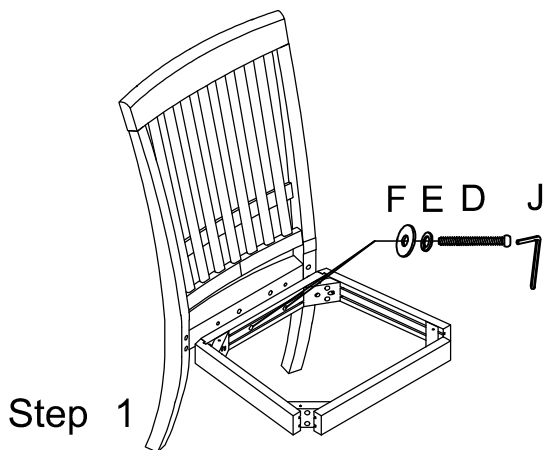

Note: Straight Allen Wrench (K) is for use with a power drill.

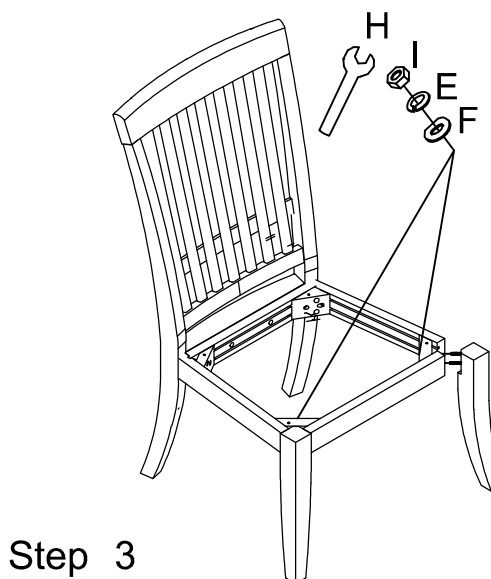

MADE IN CHINA